

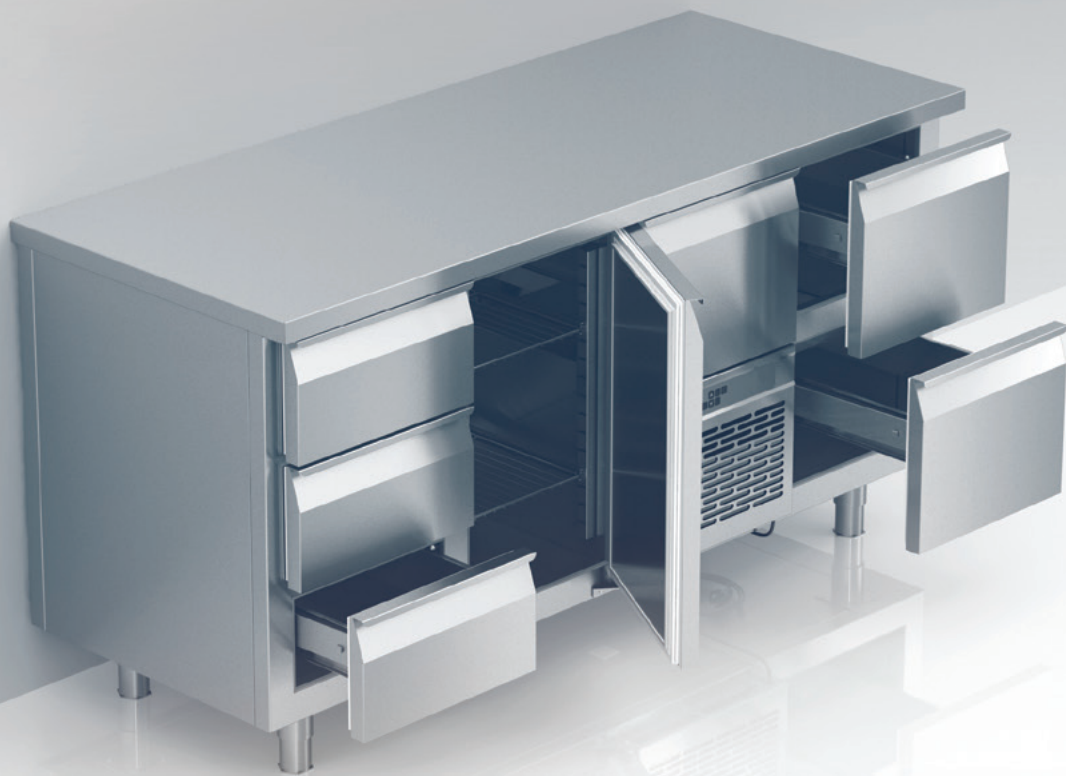

KITCHENPLUS



koel- en vries werkbanken

- innovatieve technische ruimte
- compact design
- afgestemd op uw wensen



KITCHENPLUS

koel- en vrieswerkbanken & werkbanken met saladbar

Beschikbaar in 4 afmetingen:



1.5 deur

Ⓑ 940mm Ⓓ 700mm Ⓔ 850 tot 910mm

2.5 deur

Ⓑ 1300mm Ⓓ 700mm Ⓔ 850 tot 910mm

K

 **koeling**
2 tot 8 °C
code: K94

 **koeling**
2 tot 8 °C
code: K130

F

 **vriezer**
-18 tot -2 °C
code: F94

 **vriezer**
-18 tot -2 °C
code: F130

OF

OF

saladbar

saladbar

SL



 **koeling**
2 tot 8 °C
code: SL94

 **koeling**
2 tot 8 °C
code: SL130

 **5 x**
1/6 GN

 **7 x**
1/6 GN





3.5 deur

B 1720mm D 700mm H 850 tot 910mm

4.5 deur

B 2130mm D 700mm H 850 tot 910mm

 **koeling**
2 tot 8 °C
code: K172

 **koeling**
2 tot 8 °C
code: K213

M

 **diepte koeling**
-5 tot +5 °C
code: M172

 **diepte koeling**
-5 tot +5 °C
code: M213

OF

OF

saladbar

saladbar

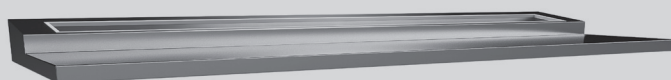
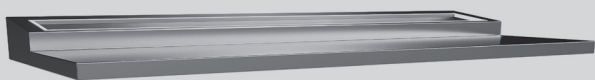

 **koeling**
2 tot 8 °C
code: SL172

 **diepte koeling**
-5 tot +5 °C
code: M172SL

 **koeling**
2 tot 8 °C
code: SL213

 **diepte koeling**
-5 tot +5 °C
code: M213

 **10 x**
1/6 GN

 **12 x**
1/6 GN





opties voor alle werkbanken

laden



Opgelet: de laden hebben geen bodem en dus enkel bruikbaar met GN bakken

3 laden

voor GN bakken tot 150^{mm} diepte
code: 3D



2 laden

voor GN bakken tot maximaal 200^{mm} diepte
code: 2D

werkblad

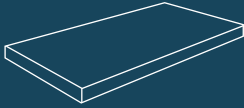

standaard werkblad
code: A

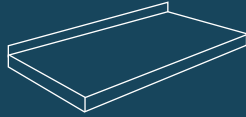

opstaande rand achteraan van 100^{mm}
code: _1



geen werkblad enkel isolatie
code: B



Bij keuze van een werkbank zonder werkblad krijgt u een corpus hoogte zonder poten van 720^{mm} voor eventuele sokkel montage

poten of wielen

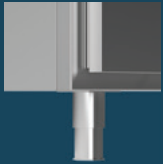

poten

Verstelbare hoogte van 850 tot 920^{mm}
code: L



wielen

Vaste werkhoogte van 910^{mm}
4 zwenkwielen waarvan 2 geremde
code: C

kleuren

Alle werkbanken zijn beschikbaar in volgende RAL kleuren:



RAL 9003
signaalwit



RAL 1013
parelwit



RAL 7001
zilvergrijs



RAL 5012
lichtblauw



RAL 5002
ultramarijnblauw



RAL 6005
mosgroen



RAL 6018
geelgroen



RAL 1016
zwavelgeel



RAL 2011
dieporanje



RAL 3020
verkeersrood



RAL 3011
bruinrood



RAL 9017
verkeerszwart



Zie RAL-kleurenwaaijer voor correcte kleurweergave.

verlengde garantie

K+ warranty plan:
3 jaar extra garantie op monoblock mogelijk



+



=



Kijk op kitchenplus.eu voor meer info over onze opties en voorwaarden



voorbeeld samenstellingen

K94
of
F94
01

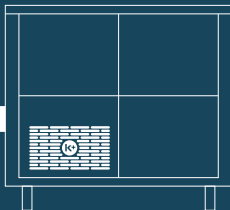

K130
of
F130
01

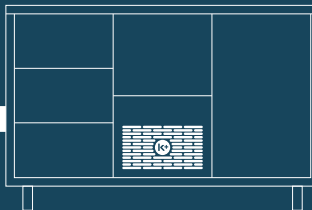

SL94
01

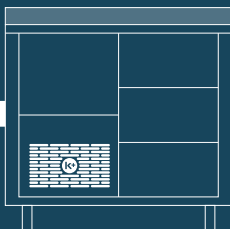

02

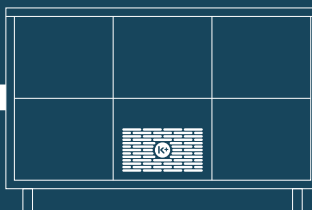

03

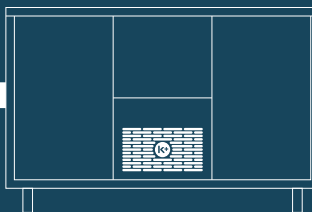

K172
of
M172
01

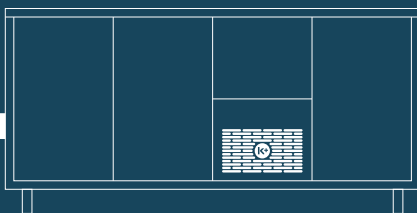

SL130
01

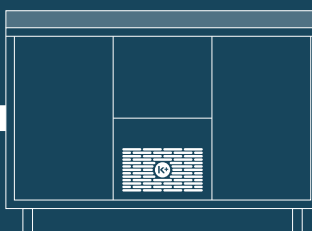

02

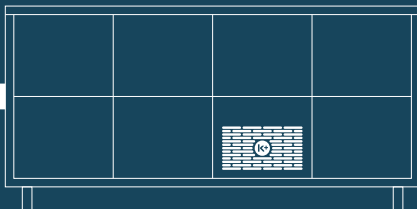

03

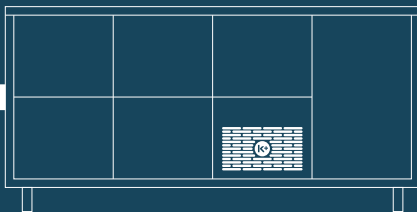

K213
of
M213
01

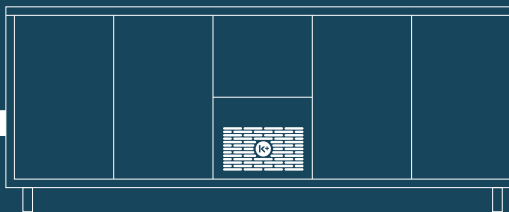

04

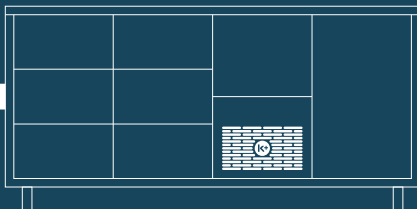

02

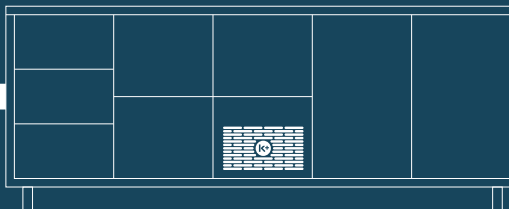

SL172
01

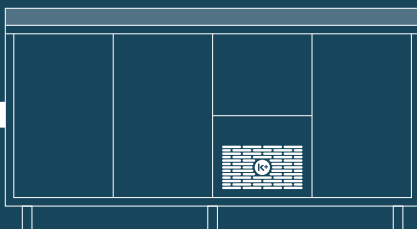

SL213
01

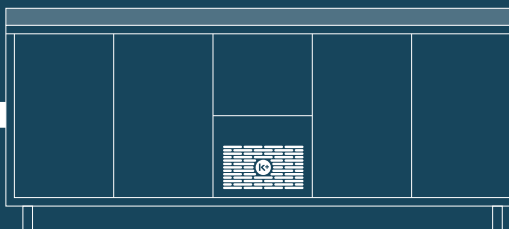

k+ algemene kenmerken

- Dubbel gecoate verdamper
- Alle delen in aisi 304-EN1.4301 inox
- Dubbel gecoate verdamper
- Standaard vlak RVS-werkblad en achterwand
- 2 RVS-draadroosters incl. dragers per deursectie
- Monoblock koelgroepen
- Sokkelmontage mogelijk

- Geïntegreerde handgrepen
- Afgeronde hoeken binnenin
- Zelfsluitende deuren
- 50^{mm} isolatie dikte
- Vervangbare deurrubbers
- Telescopische ladegeleiders



naadloos front

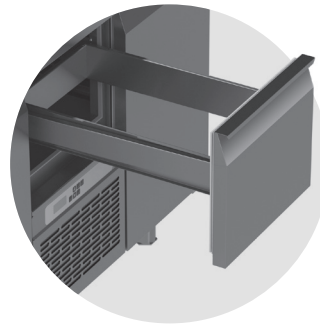

extra gekoelde lade boven koelgroep

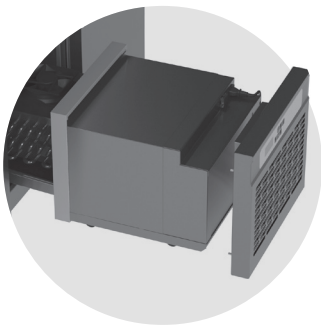

uitneembaar monoblock

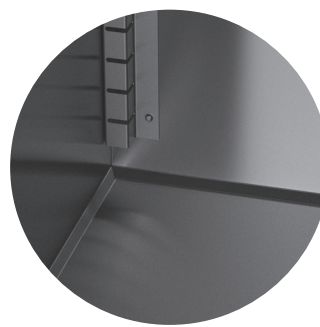

afgeronde binnenhoeken

technische specificaties

	Model 94	Model 130	Model 172	Model 213
Afmeting (mm)	940 x 700 x 850-910	1300 x 700 x 850-910	1720 x 700 x 850-910	2130 x 700 x 850-910
Koeling	1.8Amp 410 Watt	1.8Amp 410 Watt	2.1Amp 480 Watt	2.1Amp 480 Watt
Dieptekoeling	NB	NB	2.5Amp 575 Watt	2.5Amp 575 Watt
Vriezer	2.3Amp 529 Watt	2.3Amp 529 Watt	NB	NB
Bruto inhoud	200 liter	330 liter	470 liter	620 liter
Koelmiddel	R134A / R404A	R134A / R404A	R134A	R134A

Gekoelde saladbar passend
op uw K+ werkbank

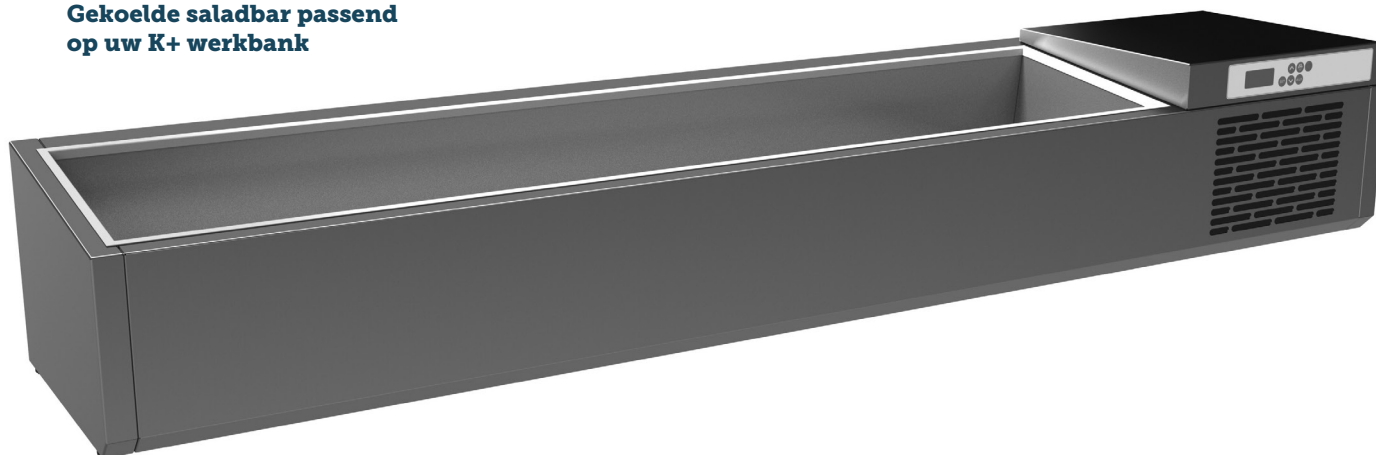

technische specificaties

	Model S94	Model S130	Model S172	Model S213
GN inhoud	2 x 1/3 + 1 x 2/6	4 x 1/3 + 1 x 2/6	5 x 1/3 + 3 x 2/6	8 x 1/3 + 2 x 2/6
Afmeting (mm)	940 x 400 x 306	1300 x 400 x 306	1720 x 400 x 306	2130 x 400 x 306
Temperatuur in °C	+2° tot +8°	+2° tot +8°	+2° tot +8°	+2° tot +8°
Aansluitwaarde	240V 1.6A 370W	240V 1.6A 370W	240V 2.3A 530W	240V 2.3A 530W

accessoires

Accessoires voor K+ werkbanken

- Extra draadrooster code: GN1
- Extra geleiders t.b.v. draadrooster code: GS1

Accessoires voor K+ werkbanken met saladbar

- Geïsoleerd inox deksel (standaard) code: DX
- Plexiglas deksel code: DG

Accessoires voor K+ gekoelde saladbar

- Geïsoleerd inox deksel code: DXS
- Glasopbouw code: DGS





KITCHENPLUS

**Liever volledig op maat?
Neem contact met uw dealer.**

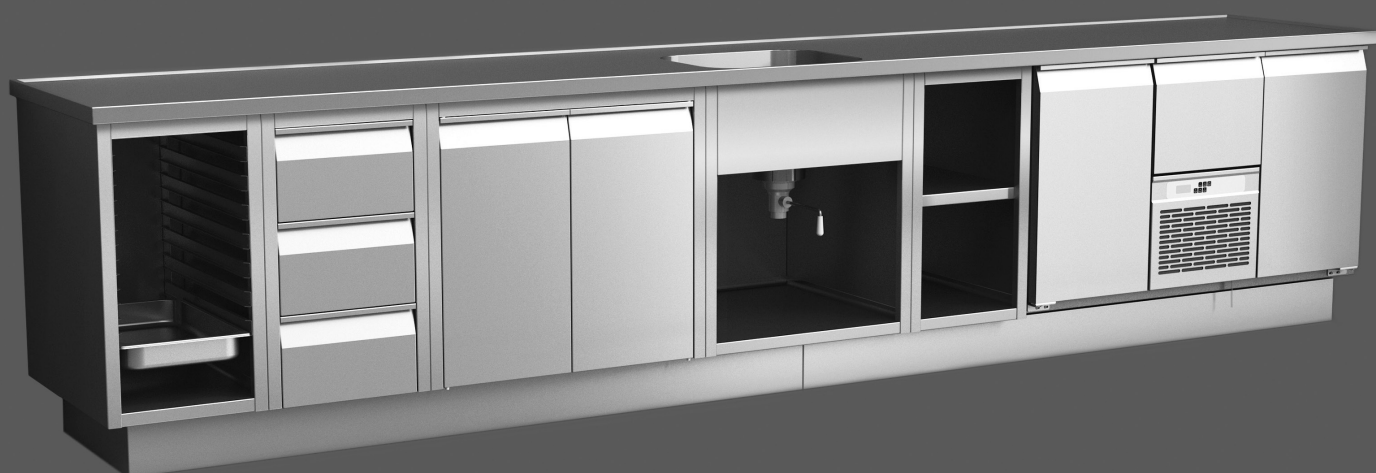

KITCHENPLUS.EU